

Standard technical specification for various model
CFC: Only Mixing no heating system included
CFCR: Mixing and heating system included

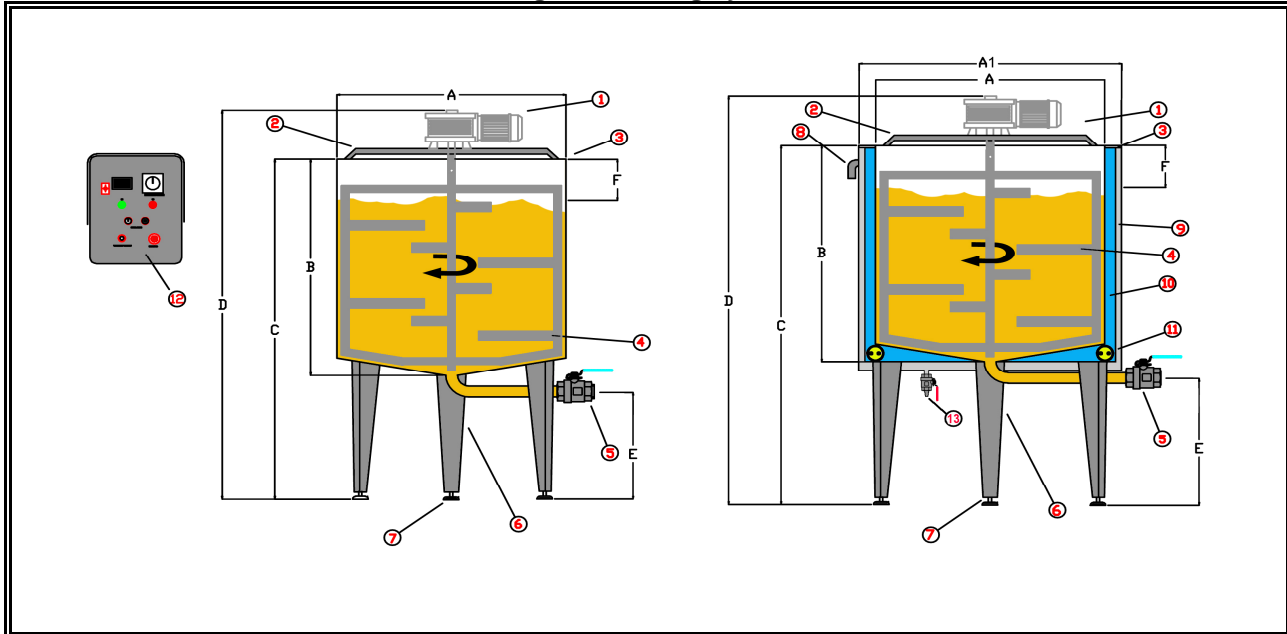

CFC 300	A1	A	B	C	D	E	F	Voltage-Power cons.
		724	800	1330	1530	380	150	220-380 V 5,0 Kw
1	Variable speed mixing motor with electronic control (5-10 Rpm)							
2	Support for mixing motor with oil containment							
3	Reinforced top edge profile							
4	Mixing anchor wigh opposid blades							
5	Drain tap with clamp connection							
6	Support legs							
7	levelling feet							
12	Control Panel							
Cylindrical framework 304 Stainless steel								
Internal surface finish: polished		External surface finish: Satin						
Saafety plane cover in two pieces with oversize opening								
Control panel complete with: Main switch, safety stop, setting and display of temperature for water bath (CFCR) Control lamp indication, speed regulation for mixing and emulsifier motor.								

Options :

Cylindrical framework 316 Stainless steel	Spry-ball for internal washing	
Mixing by impellor having different size and inclination on request.		
Product temperature display	Weighting system and relative display	
Other speed options available for emulsifier		

P.S .Dimensions subject to change - Tolerance 15 – 20 %